

360 IQ™ HAT PRESS

OPERATOR'S MANUAL



STAHL'S
Hotronix®

When using your heat press, basic precautions should always be followed, including the following:

1. Read all instructions.
2. Use heat press only for its intended use.
3. To reduce the risk of electric shock, do not immerse the heat press in water or other liquids.
4. Never pull cord to disconnect from outlet, instead grasp plug and pull to disconnect.
5. Do not allow cord to touch hot surfaces, allow heat press to cool completely before storing.
6. Do not operate heat press with a damaged cord or if the equipment has been dropped or damaged. To reduce the risk of electric shock, do not disassemble or attempt to repair the heat press. Take it to a qualified service person for examination and repair. Incorrect assembly or repair could increase the risk of fire, electric shock, or injury to persons when the equipment is used. Power supply cord must be disconnected before cleaning or servicing press.
7. This appliance is not intended for use by persons (including children) with reduced physical, sensory or mental capabilities, or lack of experience and knowledge, unless they have been given supervision or instruction concerning use of the appliance by a person responsible for their safety.
8. Close supervision is necessary for any heat press being used by or near children. Do not leave equipment unattended while connected.
9. To avoid burns, do not touch hot metal parts or the heated platen during use.
10. To reduce the likelihood of circuit overload, do not operate other high voltage equipment on the same circuit.
11. If an extension cord is necessary, then a 20-ampere rated cord should be used. Cords rated for less ampere may overheat. Care should be taken to arrange the cord so that it cannot be pulled or tripped over.
12. Keep hands clear of the upper heat press platen during lock down as the pressure may cause injury.
13. Heat press should be placed on a sturdy, suitable stand at least 36"L x 24"W x 29"H.
14. Work area must be kept clean, tidy and free of obstructions.

Table Of Contents

Safety Instructions 2

Machine View 4

Operating Instructions 5-7

Connecting the System 5

Start Up/Shut Down 5

Home Screen 6

Prepare to Print 7

Touch Screen Guide 8-11

Setup Menu 8

Password Setup 8

Preset Setup 9

Date & Time Setup 10

Display Setup 10

Auto On & Off Setup 10

System Setup 10

Calibration 11

Updating Software 11

Connect to the IQ® Portal 12

Electrical Schematic 13

Replacement Parts List 14-15

Contact 16

HOTRONIX[®] 360 IQ[™] HAT PRESS

Machine View



Operating Instructions

Connecting the System

Insert power cord into IEC Inlet located on the side of press (1.1).

Connect the power cord into a properly grounded electrical outlet with a sufficient amperage rating.

To remove a locking power cord (if equipped), press the two red buttons while pulling on the plug (1.2).



1.1

Voltage

120 volt presses require a full 6-amp grounded circuit.

240 volt presses require a full 3-amp grounded circuit.

Extension Cords

If used, extension cords should be as short as possible and not less than 12 gauge. Heavy duty cords are recommended.

Circuits

Circuits that have less than 10 amps, or have other high demand equipment or appliances (especially more than one heat press) plugged in, should not be used.

Note: If supply cord is damaged, it must be replaced by the manufacturer, its service agent, or a similarly qualified person to avoid hazard. Use SJT type rated 300 V cord for replacement.



1.2



2.1

Start Up/Shut Down

Locate the packaging bolt on top of press and remove prior to turning on or operating (2.1).

Flip the power switch ON (2.2). A splash screen displaying the Hotronix® logo and current software version is shown for several seconds.

To turn heat press off, flip the power switch OFF.

To place heat press into Standby Mode, touch and release the Power icon on the Home Screen (3.2 - following page). In Standby Mode, the heater turns off while the Touch Screen remains on, displaying an orange background as a warning if the platen is still hot (above 100°F/38°C).

NOTE: Standby Mode must be used for the Auto On feature to function (10.1). The Auto On feature will not work if the power switch (2.2) is in the OFF position.

To start up your heat press while in Standby Mode, touch and release the Home icon on the Standby Screen.



2.2

Home Screen

Status bar provides helpful information regarding heat press.

Touch and edit your favorite presets.

Lock the screen (Manager-level only) to prevent User-level operators from changing settings.

Touch and edit Users to control operator access level and track press usage by operator in the IQ® Portal.



3.1

Displays current top heater temperature.

Displays current bottom heater temperature.

Displays current application pressure and time.

IQ® Portal and WIFI connection status.

Touch Setup Menu.

Place press in Standby Mode to take advantage of the scheduled Auto On feature.

Displays the selected preset. Touch and hold to see application settings.

NOTE: Holding down material name will display targeted application settings. Screen displays current temperature, pressure, and time.

Displays multiple heat application preset step. Touch the empty circled numbers to switch between preset steps.

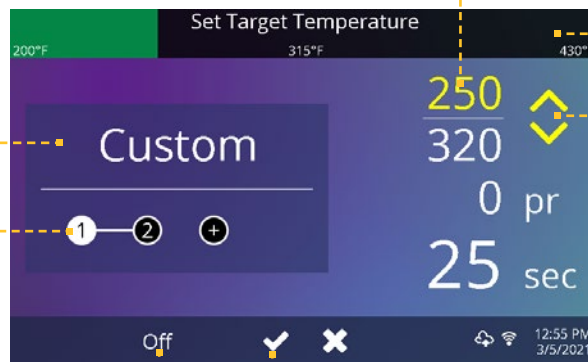

3.2

Tap any print parameter to adjust its target value.

Tap a section of the top bar to quickly jump to the corresponding value.

Tap up/down arrows for fine adjustment of target value.

Tap Check Mark icon to accept new value or X to cancel.

Tap "Off" to disable heater.

Prepare to Print

Before heat applying, set the target settings for the selected transfer material by:

- Selecting a Preset (7.1), or
- Manually entering target temperature, time, and pressure.

Temperature and time are controlled automatically. Pressure must be set manually:

- Position a cap on the lower heater (4.1).
- Lower the cap hold-down lever (4.2) to lock in place.
- Enable Target Temp option in System settings (11.1) to prevent the electromagnet from locking down until temperature is reached.
- Pull lift handle down and observe the pressure reading.
- Adjust the pressure by turning the Pressure Adjustment Knob.

A visual pressure readout is located on the Home Screen. When the handle is locked in the PRINT position, a pressure number between 0-9 is displayed.

- 0 = No Pressure.
- 1 - 3 = Light Pressure.
- 4 - 7 = Medium Pressure.
- 8 - 9 = Heavy Pressure.

WARNING: Structural damage caused by excessive pressure is not covered under the limited warranty!

The lower heater alignment can be adjusted by loosening the knob to accommodate different cap sizes (4.3).

When the desired temperature is reached:

- Position the cap and design (4.1).
- Lower the cap hold-down lever to lock cap into place (4.2).
- Pull lift handle down and begin to heat apply.
- The automatic timing process will begin.
- The Home Screen will initiate a count down and lift the heat platen into the UP position when print cycle is complete (4.4).

Tips for Successful Printing:

- Hold hat by the sides of bill and load from side of platen.
- Align seam of bill with lip on lower platen for access to full print area.
- Extend sweatband out when possible to ensure smoother application.
- Cover logo with included pad matching thickness of material.
- Always best to remove hat from press before peeling backing to let adhesive cool and set.
- Don't pick or pull at emblem or patch for 24 hours to ensure adhesion.



4.1



4.2



4.3



4.4

Setup Menu

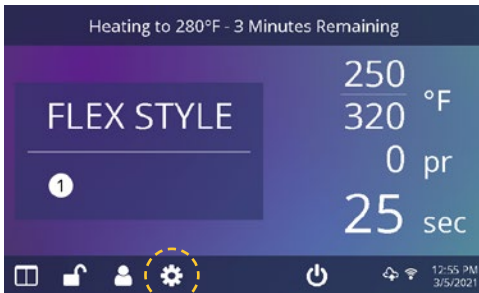

5.1

Touch the Settings icon on the Home Screen (5.1) to configure your heat press.

Managers can access all setup options, while Users can access a limited set (5.2).

- Managers default password: M

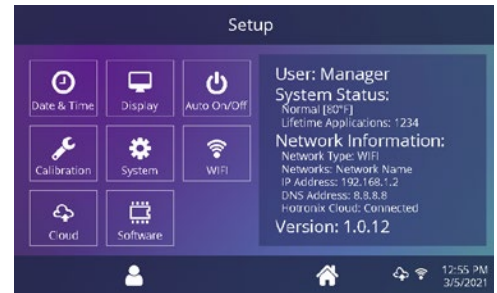

5.2

Password Setup (Manager-Level Only)

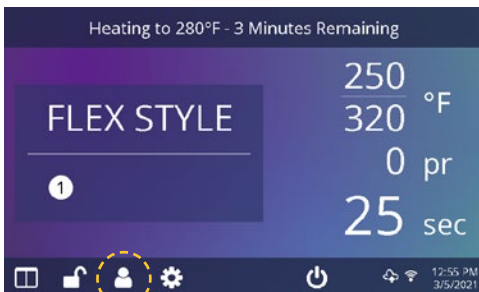

6.1

Touch the User icon on the Home Screen (6.1) or Setup Menu (6.2) to select, add, and edit Users.

Touch and edit Managers and Users to configure access to settings (6.3, 6.4). Heat press reports on the IQ® Portal can be filtered by User to track individual operator performance.

Touch arrow keys on the taskbar to scroll through a long list of Users (6.5).

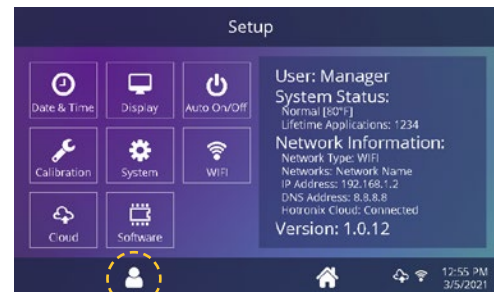

6.2

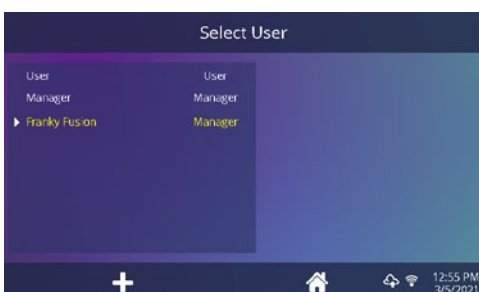

6.3

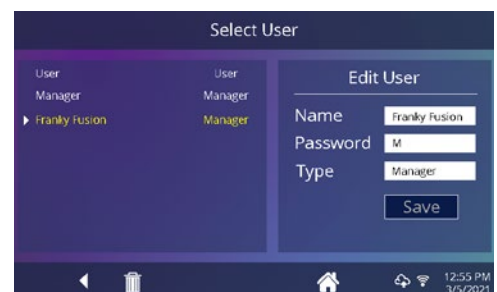

6.4

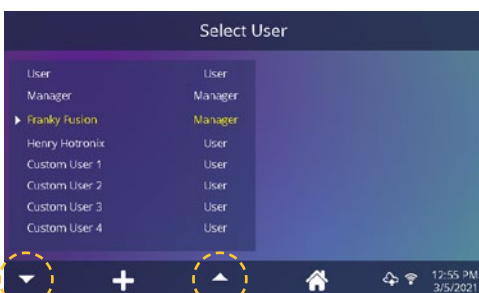

6.5

Preset Setup

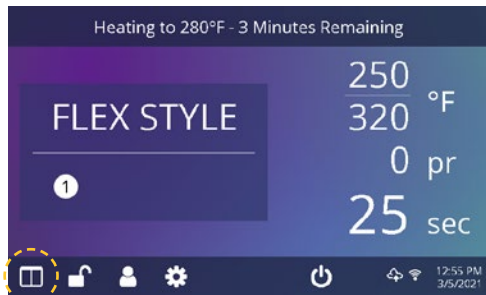

7.1

Touch the Columns icon (7.1) to select from a list of saved presets (7.2).

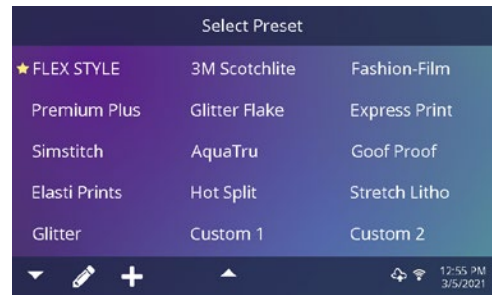

7.2

Touch arrow keys on the taskbar to scroll through a long list of presets (7.3).

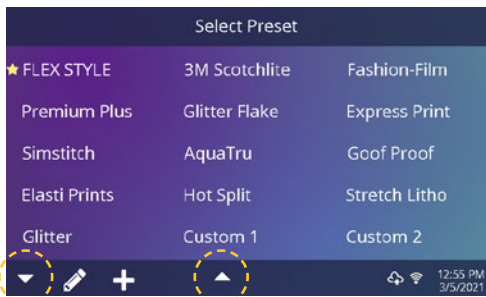

7.3

Touch the Pencil icon (7.4) to enter edit mode, then touch preset name to edit settings. Touch Save to save changes.

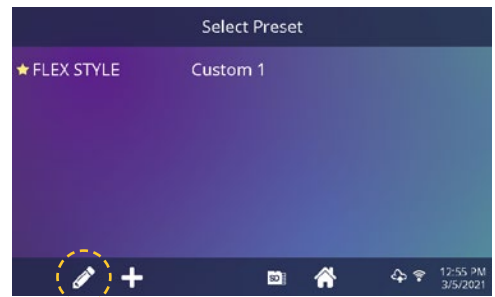

7.4

Touch the Plus icon to create a new preset (7.5).

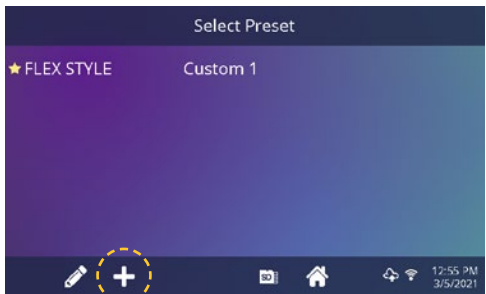

7.5

Name your preset and enter desired temperature, time, and pressure. When creating a new preset, the current Home Screen application settings are selected automatically (7.6).



7.6

Touch the empty circled numbers to set multiple preset stages for pretreatment or multi-step applications (7.7).



7.7

Date & Time Setup

Touch the Settings icon on the Home Screen.

- Touch Date & Time, information displays on right of screen (8.1).
- Touch up/down arrows to select time zone.
- Touch Auto to automatically synchronize the heat press clock.
The heat press must be connected to a WIFI network with access to the Internet.
- Touch Daylight Saving to enable daylight saving mode.
This option should be enabled during summer.

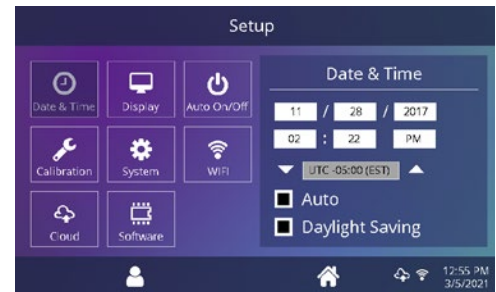

8.1

Display Setup

Touch the Settings icon on the Home Screen.

- Touch Display, information displays on right of screen (9.1).
- Touch Temperature to switch between F° or C°, then touch Check Mark icon on taskbar to save.

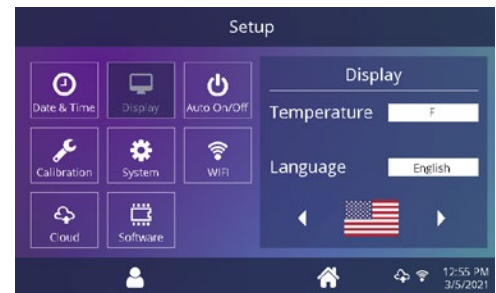

9.1

Auto On & Off Setup

Touch the Settings icon on the Home Screen.

- Touch Auto On/Off, information displays on right of screen (10.1).
- Touch Enable, then On Hour/Minute and Off Hour/Minute, selecting Enter between each setting. Once entered, touch Check Mark icon on taskbar to save.

NOTE: Standby Mode must be used for the Auto On feature to function (3.1).
The Auto On feature will not work if the power switch (2.2) is in the OFF position.

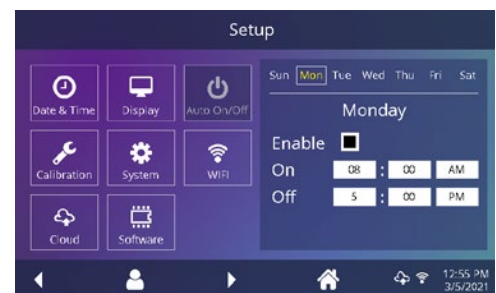

10.1

System Setup (Manager-Level Only)

Touch the Settings icon on the Home Screen.

- Select System, information displays on right of screen (11.1).
- Touch Power Save and select time, then touch Check Mark icon on taskbar to save. When enabled, your heat press will enter Standby Mode if it's not used for the specified number of hours.
- Touch Target Temp to prevent the electromagnet from activating until temperature is reached.

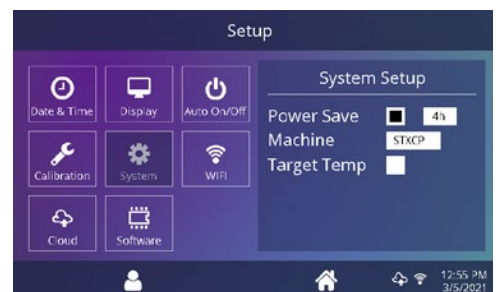

11.1

Calibration (Manager-Level Only)

Your heat press comes pre-calibrated from the factory. Calibration is only required after sensor or controller replacement. Pressure is periodically self-calibrated. Incorrect calibration can result in poor print results or damage to your heat press which is not covered by warranty.

Your heat press has a temperature calibration function (12.1).

- Turn on heat press and heat to 280°F/138°C top heater and 320°F/160°C bottom.
- Measure center of heater with contact thermocouple (not infrared) thermometer.
- Touch the Settings icon on the Home Screen.
- Touch Calibration, information displays on right of screen.
- Touch Temperature 1 for the top heater and adjust Temperature Calibration to match Target Temperature.
- Touch Temperature 2 for the bottom heater and adjust Temperature Calibration to match Target Temperature. Remove rubber cap and adjust 100°F-105°F below measured temperature for best results.

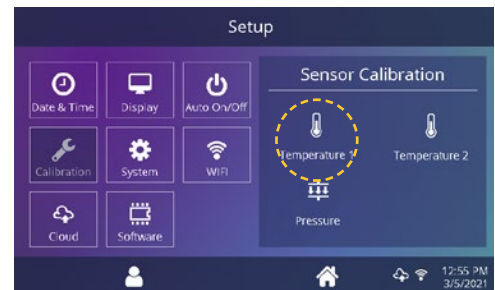

12.1

Your heat press has a pressure calibration function (12.2).

- Touch the Settings icon on the Home Screen.
- Touch Calibration, information displays on the right of screen.
- Touch Pressure, Calibrate and wait for screen to display initial reading (about 2.5V).
- Turn Pressure Adjustment Knob counterclockwise (reducing pressure) until it stops.
- Place one thin (1/8" 3mm) white pad on mandrel, lower print handle into print position until electromagnet lightly contacts magnet plate.
- Tap Set Min Point (should display approximately 2.4V or 0.1V below initial reading).
- Raise print handle.
- Turn Pressure Adjustment Knob clockwise (increasing pressure) 3 full turns, lower print handle into print position until electromagnet lightly contacts magnet plate.
- Tap Set Max Point (should display approximately 2.2V or 0.3V below initial reading).
- Raise print handle.

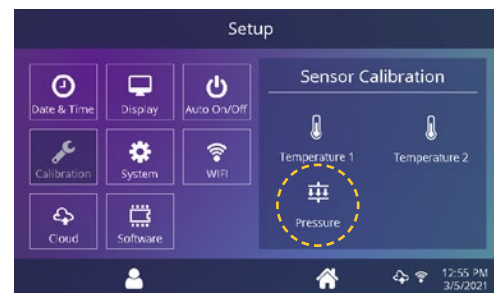

12.2

Updating Software

Touch the Settings icon on the Home Screen.

- When a software update is available, an exclamation point appears after the version number in the Setup Menu (5.2).
- Touch Software, information displays on right of screen. An available online update displays a Cloud icon (12.3).
- Touch Update File on right of screen, then touch Check Mark icon on taskbar to start download. A downloaded update displays a Memory Card icon.
- Touch Downloaded Update File on right of screen, then touch Check Mark icon on taskbar to start installation.

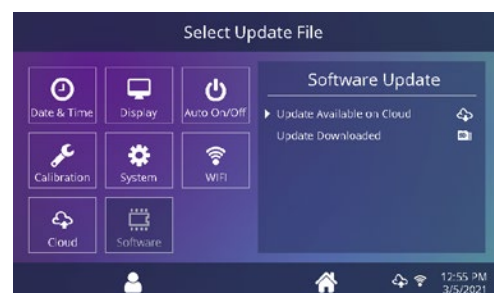

12.3

NOTE: If a power failure occurs during installation, the heat press will attempt to install the previous software version.

Create Your Account

- Using a phone or computer, visit iq.hotronix.com to create an account (13.1).
- Enter your name, email, and password.
- Click on the confirmation link in the email you receive.
- Your account has been created.

Register a Heat Press

- Click on Manage Heat Presses, then New Heat Press.
- Select heat press type, enter serial number, and enter a name for the heat press (optional).
- Click on Create Heat Press and enter the verification code given.
- On the heat press Setup Menu, touch WIFI and connect to your WIFI router or mobile hotspot (13.2).
- On the heat press Setup Menu, touch the Cloud icon and enter the verification code displayed in the IQ® Portal (13.3).
- Your heat press has been registered.

Create & Assign Users

- Click on Manage Operators, then New User.
- Enter a name and select a privilege level. Managers can access all heat press settings while Users have limited access.
- Click on New User, then Assign Machines in the sidebar.
- Select a machine and click Assign.
- On the heat press Setup Menu, touch the Cloud icon, then Manual Sync (13.4).
- Reporting will show impressions made by Users.

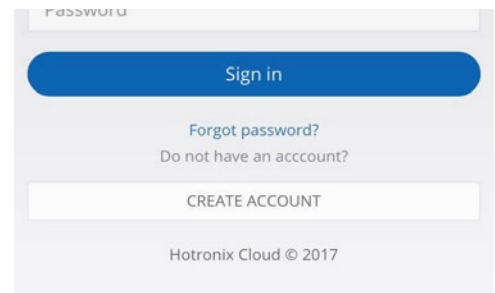

13.1



13.2

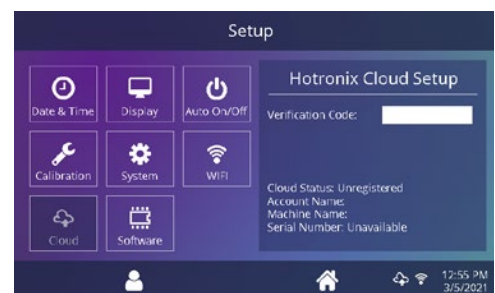

13.3

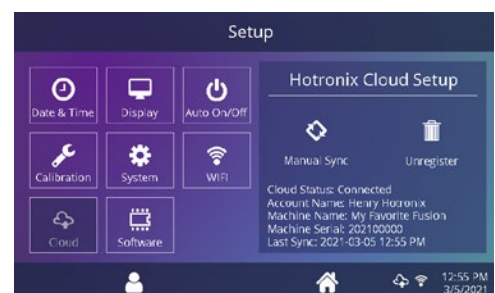

13.4

Electrical Schematic

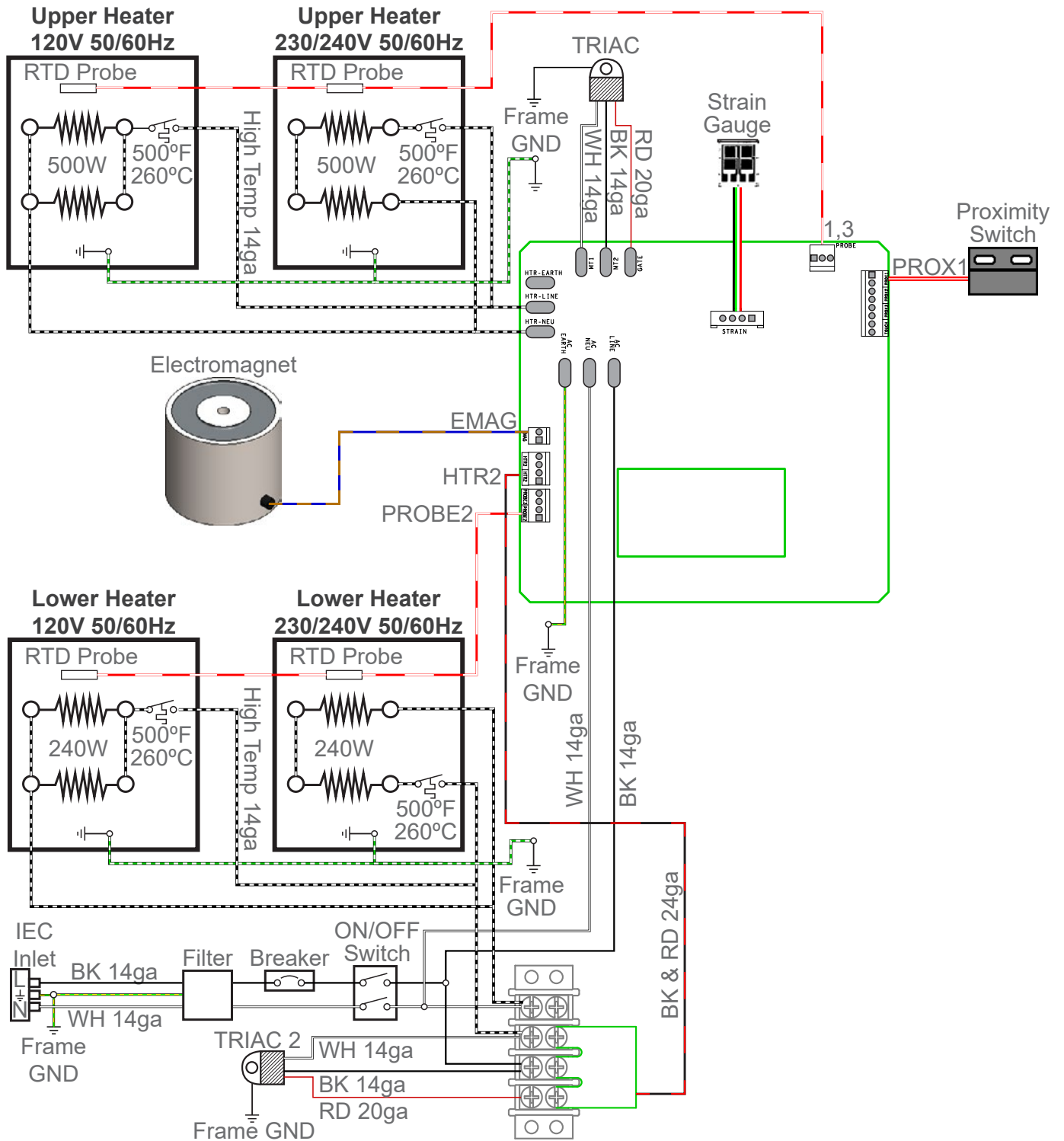

HOTRONIX® 360 IQ™ HAT PRESS

Replacement Parts List

#	PART#	DESCRIPTION	QTY.
1	4-1183	Heater Arm, 360 IQ Hat	1
2	2-1055-11	Steel Pin, 1/2" x 5-9/16"	1
3	1-1107-1	Hub Cap 1/2"	2
4	1-1048-3	Washer, 1/2" Nylon	16
5	1-2617	Conduit Fitting, 1/2 NPT-21mm HPASC	1
6	1-2619	Conduit Fitting Nut, 1/2 NPT	2
7	1-2605	Threaded Insert, 1"-8 to 5/8"-11	1
8	-	Heater Arm Panel, Rear	1
9	-	Heater Arm Panel, Front	1
10	1-2104	Silicone Pad, 5/16" ID x 1-3/4" OD x 1/4" T	1
11	1-1945-1	Electromagnet	1
12	-	Steel Pin, 1/2" x 7"	1
13	1-2606	Shaft Collar, 1/2" One-Piece Clamp-On	6
14	1-1219	Proximity Magnet	1
15	3-1011-13	Screw, Pan Phillips #6-32 x 1.00	12
16	2-1006-50	Nut, #6-32 Hex with Lockwasher	6
17	3-1011-10	Screw, Machine #8-32 x 1/4"	13
18	3-1011-185	Screw, Shoulder 5/16" x 3/4"	1
19	3-1011-281	Set Screw, 5/16"-18 x 1/4"	2
20	3-1386	Heater, Upper, 360 IQ Hat, 500W	1
21	1-2076	Thermostat Disc	2
22	2-2147	Adjustment Spindle, Cap	1
23	1-1095	Knob, Black Plastic 3/8"-16	1
24	3-1011-238	Bolt, Hex Head 5/16-18 x 3-1/2"	1
25	1-2163	Spring, 1/2"D x 3/4"L, 62lb/in	1
26	1-2608	Silicone Cap, 1/2" x 1"	1
27	3-1011-98	Screw, SS Sheet Metal #4 X 1/4"	5
28	1-1272-1	Temperature Probe	2
29	3-1385	Heater, Lower, 360 IQ Hat 240W	1
30	1-2609	Insulation, 1/8" x 2.75" x 5.75"	1
31	2-1006-101	Washer, #6 Oversized	1
32	2-1006-110	Weld Nut, 1/4"-20 Steel	1
33	1-2610	Dowel Pin, 1/4" x 3/4" Pull-Out	1
34	3-1011-242	Screw, Socket Head Cap 1/4-20 x 1.125	1
35	-	Lower Heater Plate, 360 IQ Hat	1
36	2-1006-25	Washer, Flat 1/4" SAE	2
37	2-1006-46	Washer, 5/16" SS	1
38	1-2592	Thermal Snap Cap	1
39	4-1179	Lower Frame, 360 IQ Hat	1
40	1-2611	Loop Clamp, 3/8" Galv Steel	1
41	-	Lower Support Cover, 360 IQ Hat	1
42	1-2463-F	Fusion IQ Controller	1
43	1-2463-P	Fusion IQ Power Board	1
44	1-2473	Fusion IQ Power Bracket	1
45	3-1011-235	Screw, Sheet Metal #6 x 1/2"	6
46	1-2474	Fusion IQ Latch	2
47	1-2485	Spring, 1/4" x 1", 1.7lbs/in	2
48	-	Spacer, 1/4" x 1/4" Slotted	2

#	PART#	DESCRIPTION	QTY.
48	-	Washer, #8 Stainless	1
50	1-2612	Silicone Pad, 1/4" x 1" Self-Adhesive	2
51	3-1011-25	Screw, Machine #6-32 x 1/4"	6
52	1-2386	Touchscreen Stylus Holder	1
53	1-2385	Touchscreen Stylus	1
54	-	Cable Mounting Plate	1
55	-	Washer, .375 x .203 x .020 #10 Stainless	1
56	4-1180	Cap Hold Down, 360 IQ Hat	1
57	2-1006-111	Nut, #8-32 Cap Stainless	1
58	1-1073	Spring	1
59	-	Base Plate, 360 IQ Hat	1
60	1-2575	Rubber Foot	4
61	4-1181	Base Channel, 360 IQ Hat	1
62	2-1006-112	Nut, M8x1.25 Cap	4
63	3-1011-243	Screw, Socket Head 1/4"-20 x 3/4"	8
64	3-1011-100	Screw, Socket Head 5/16"-18 x 3/4"	8
65	2-1006-44	Washer, Split Lock 1/4"	8
66	2-1006-86	Washer, Split Lock 5/16"	8
67	1-1059	TRIAC	2
68	1-2572	TRIAC Driver Board	1
69	3-1011-127	Screw, Machine #8-32 x 3/8" Black Oxide	15
70	-	Handle Weldment, 360 IQ Hat	1
71	2-1055-8	Steel Pin, 1/2" x 6-1/2"	1
72	1-1042-1	Threaded Rod .250-20 x 5.25	1
73	2-1006-2	JCN - NUT	2
74	1-1049-11	PVC Spacer, 1/2" x 5"	1
75	-	Magnet Plate, 360 IQ Hat	1
76	1-1540	Foam Grip, Black	1
77	1-1939	Ball Stud 10mm	4
78	2-1006-20	Nut, Hex Nylok 5/16"-18	2
79	1-2614	Gas Spring, 360 IQ Hat	2
80	-	Link Weldment, Right, 360 IQ Hat	1
81	-	Link Weldment, Left, 360 IQ Hat	1
82	4-1182	Column, 360 IQ Hat	1
83	1-1759	Power Inlet	1
84	1-1331-2	Circuit Breaker 10A (220V & 11x15)	1
85	-	Column Back Plate, 360 IQ Hat	1
86	1-2618	Conduit Fitting, 1/2 NPT-90-21mm HPASC	1
87	-	Proxy Plate, 360 IQ Hat	1
88	1-1056	Rubber Foot, Small Push-In	2
89	1-2087	Power Switch	1
90	3-1011-22	Screw, Machine #4-40 x 3/8"	2
91	2-1006-51	Nut, #4-40 with Tooth Washer	2
92	1-1211	Proximity Switch	1
93	3-1011-282	Set Screw, 5/16"-18 x 3/4"	1
94	1-2590	Filter, Schaffner FN2090-6-06	1
95	-	Ferrite Core 461167281	1
96	2-1048-3	Conduit, 21mm HPAS	1

Parts Location Guide

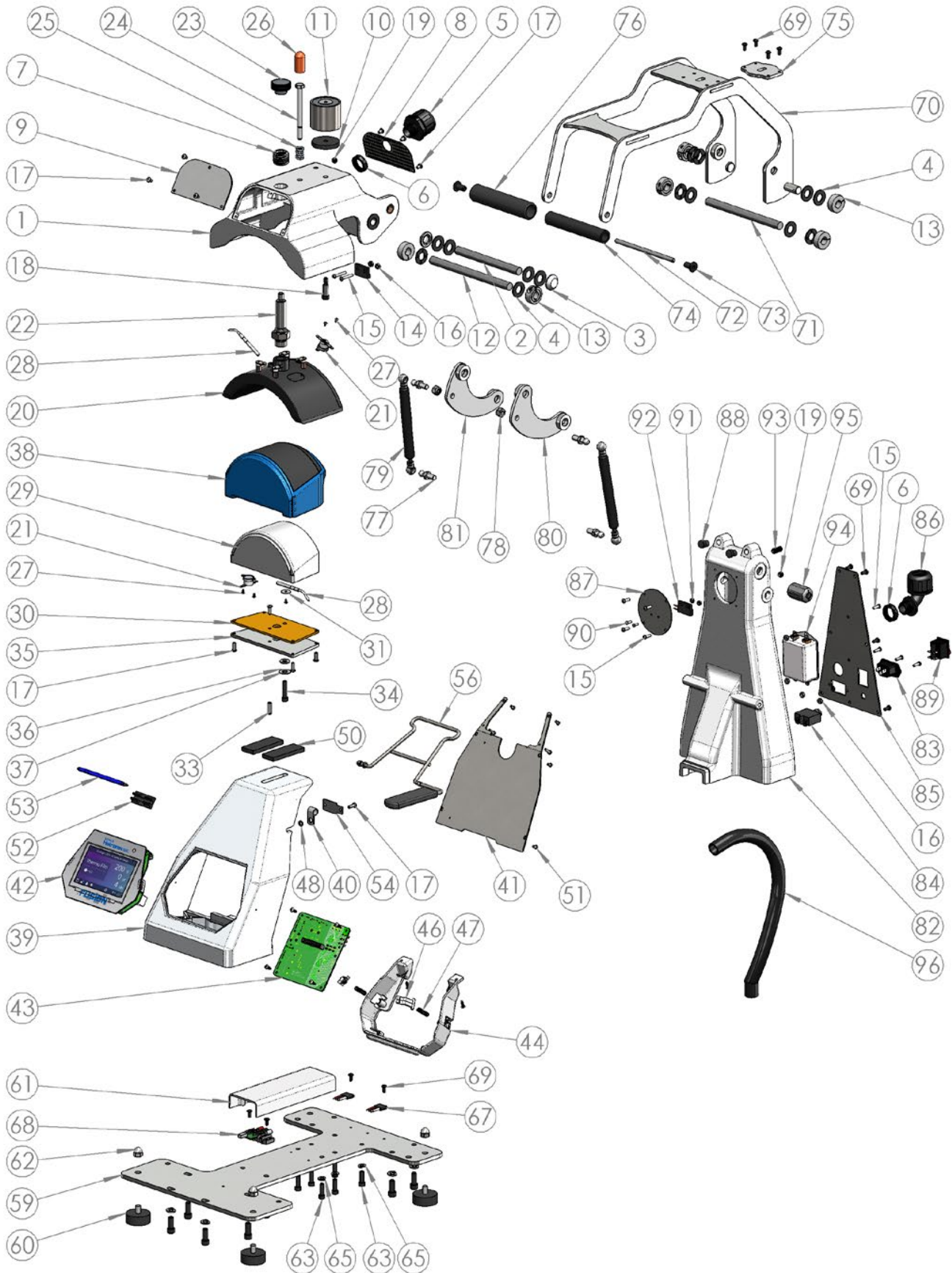

CONTACT US

STAHL'S Hotronix®

One Industrial Park
Carmichaels, PA 15320
U.S.A.

Technical Support

hotronix.com/support

Customer Service

customerservice@hotronix.com

Replacement Parts

800.727.8520
8AM - 7PM EST

Web

hotronix.com

