



OPERATING INSTRUCTIONS

for the vinyl cutters

**Secabo C60 V, C120 V
S60 II, S120 II**

Congratulations on the purchase of your Secabo vinyl cutter!

Please read the operating manual carefully to easily integrate your unit into your production environment.

Any type of reproduction of this operating manual requires the written permission of Secabo GmbH. Changes and errors in the technical data and the product characteristics are reserved. The Secabo GmbH is not liable for any direct or indirect damages occurring as a result of the use of this product.

Version 2.0 (21.06.2016)







Safety measures

Please read the information and safety measures carefully prior to initial operation of the unit!

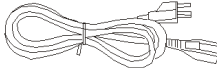
- Do not place any magnetic objects in the vicinity of the cutting head; otherwise uniform contact pressure is not ensured.
- Do not remove the connection cable from the computer while a cut job is in progress.
- Release the pressure on the pressure rollers when not in use by moving the pressure lever up.
- Do not reach into the unit when it is connected to an electricity supply
- Never open the casing and do not make any modifications to the unit yourself.
- Ensure that neither liquids nor metal objects are put inside the vinyl cutter.
- Ensure that the wall socket used is grounded and protected with a ground fault switch.
- Ensure that the connected voltage (220V) does not deviate by more than $\pm 10\%$. Otherwise install a voltage stabilizer.
- Pull the power plug if the unit will not be in use for a longer period of time.
- Never reach into the unit in the vicinity of the blade holder during the cutting operation!
- Discontinue any printing jobs in progress before readjusting the blade holder!
- Always ensure that the vinyl cutter is out of reach of children during operation and never leave the unit or individual parts of it switched on without supervision.
- Do not touch the tip of the sliding blade to avoid injury.
- Always place the unit on a stable base to prevent it from falling down.
- Do not operate the unit during thunderstorms; it can be damaged or destroyed by lightning.

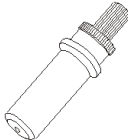
Items included

Before starting work, please check whether the following items are all present:

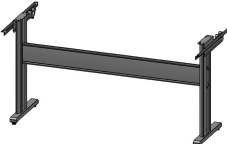
Article	Quantity	
Vinyl cutter	1	
Power cable	1	
USB connection cable	1	
Blade holder	1	
Pen holder	1	
30° Drag knife	1	
Pen head	1	
DrawCut LITE license certificate	1	
Floor stand with roll holder	1	

Assembly of the floor stand

Your Secabo vinyl cutter's floor stand (60 and 120 models) is easy to assemble using the supplied parts. Simply follow these steps:

Step 1 and 2:

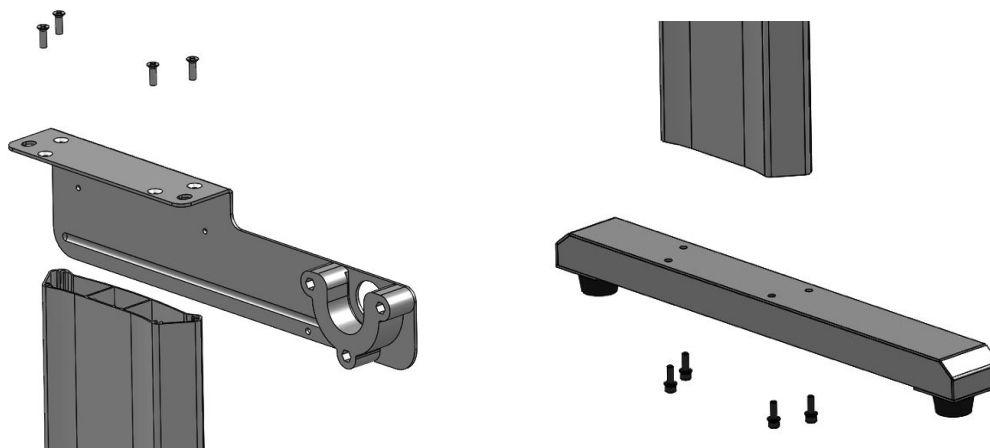

Step 3 and 4:

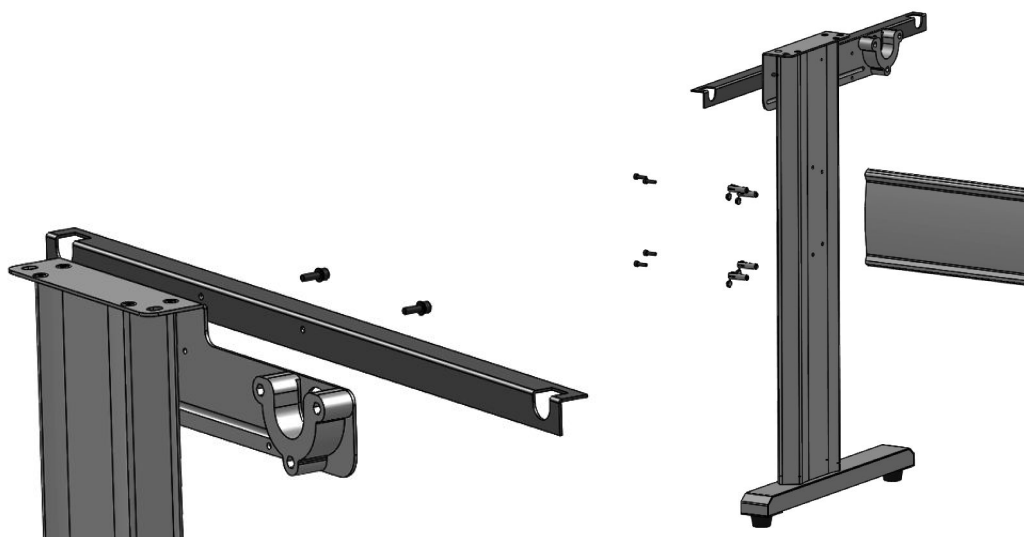

Done!

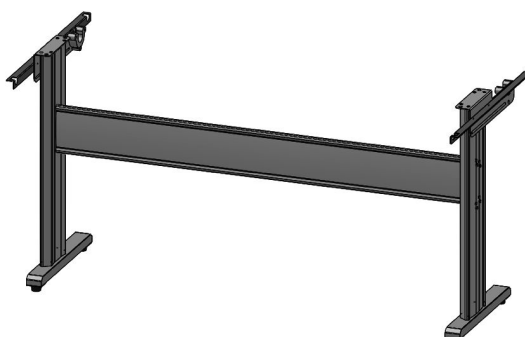

Device parts and their function

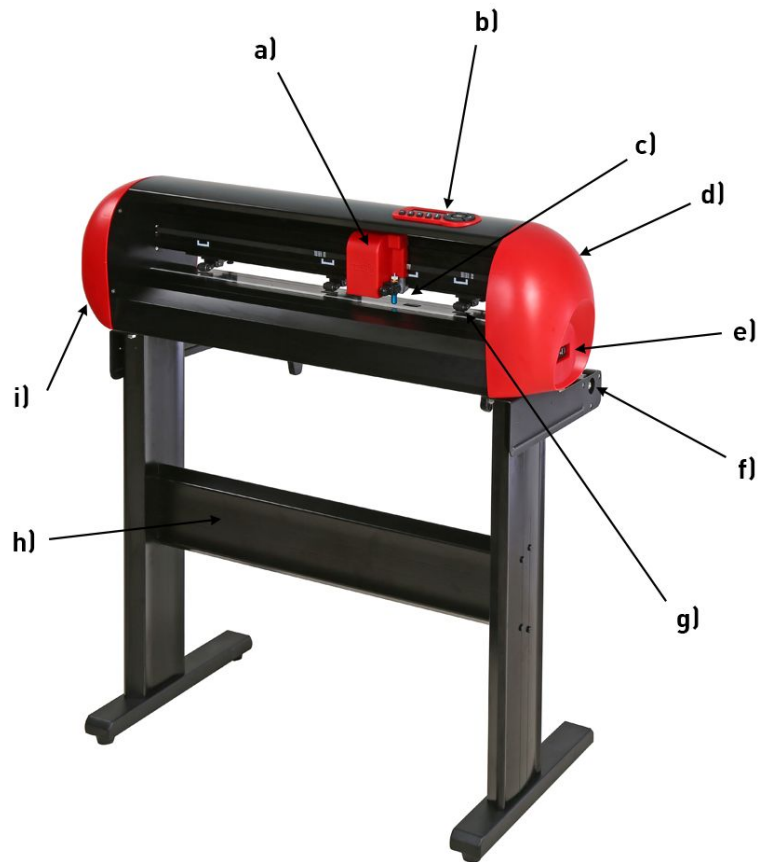

- a) Cutting head with LAPOS laser diode
- b) Control panel
- c) Blade holder
- d) Pressure lever for all pinch rollers (w/out fig.)
- e) USB interface
- f) Roll mount
- g) Pinch rollers
- h) Floor stand
- i) Power supply and power switch (w/out fig.)

Control panel



Initial operation of machine and software

Caution! Please note that DrawCut LITE or PRO must be installed first to allow for a smooth installation and complete configuration.

Installation DrawCut LITE

Our Secabo vinyl cutters are delivered with the cutting software DrawCut LITE. This software must be activated over the internet. You do not necessarily need internet access on the computer, on which DrawCut LITE will be installed. The activation can also be done through another computer.

In order to control your vinyl cutter via your computer, install the software as described below:

- Disable the Windows Firewall and your anti-virus software for the time of installation.
- Download the current version of DrawCut LITE at <http://www.draw-cut.com/#downloads> and follow the installation wizard.
- Find your 26-digit DrawCut serial number on the printout that was delivered with your Secabo vinyl cutter. Enter it when you are prompted to do so.
- Now you can use DrawCut LITE.

Installation of your Secabo vinyl cutter in DrawCut

Please keep in mind that your Secabo vinyl cutter can only be operated under Windows XP, Windows Vista, Windows 7, Windows 8, Windows 8.1 and Windows 10. Operation with an older version of Windows is not possible.

- First, make sure that your PC is connected to the Internet.
- Connect the vinyl cutter to your computer using the supplied USB cable.
- Switch on the device.
- Your Secabo vinyl cutter will now be detected. Windows will search for the appropriate drivers and automatically install them. This can take some time. Afterwards, the device will be ready for operation.
- Start DrawCut.
- Next, open the "Vinyl Spooler" in Drawcut.

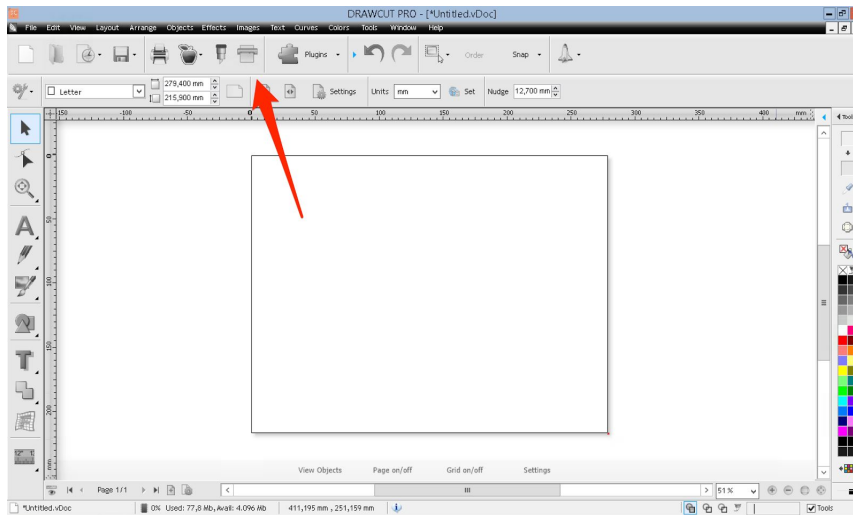

- Now click on the "Connections" tab.

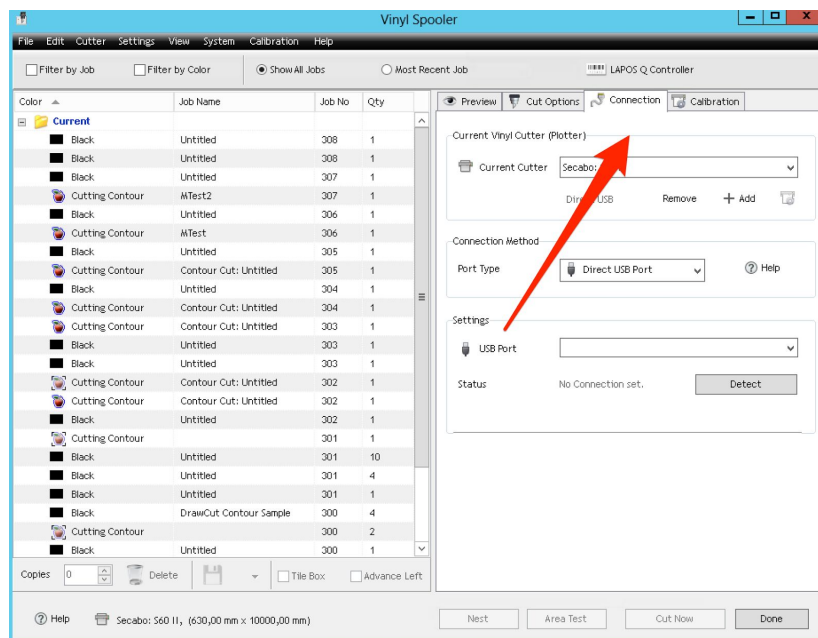

- Next, add your vinyl cutter by pressing the "Add" button (a Secabo S60 is used in the example), select your model and click "Install".

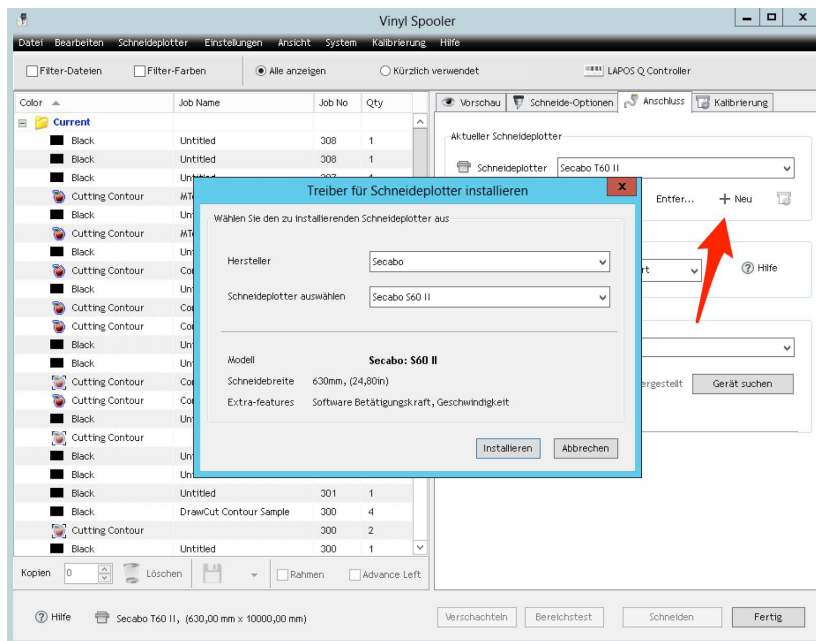

- Click on the button labeled "Search device" and follow the instructions in the installation wizard. Confirm the message regarding successful installation by simply clicking on the button labeled "Done". Now you can control your Secabo vinyl cutter using DrawCut.

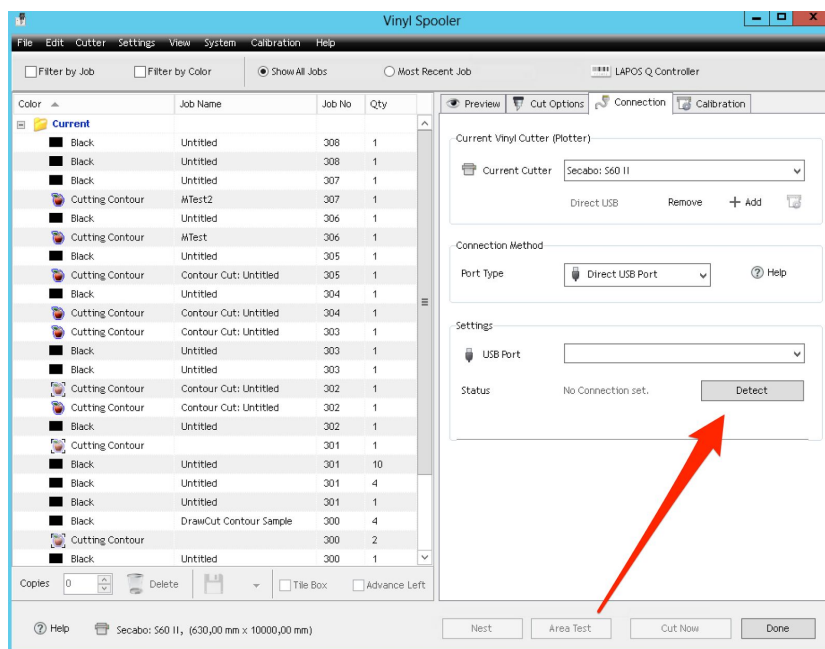

Initial operation of the device

Make sure that there is sufficient space for the film transport in front of and behind the device. The cutter may only be operated in a clean and dry environment.

- Connect the vinyl cutter to a 230 V socket using the supplied power cable.
- Now switch on the cutter.

Installing and adjusting the blade

- Take the supplied cutting blade and place it in the blade holder in such a way, that the sharp side extends at the front.
- Now set the cutting depth by turning the screw at the upper end of the blade holder.
- Initially, the depth is set correctly if you can carefully move your fingertip across the blade and feel only a light scratching. Since the depth adjustment for the blade depends on the material, it may be necessary to adjust it later.
- Secure the blade setting by tightening the gold lock nut.
- Press the pin on the rear end of the blade holder to remove and replace the blade at any time. Caution - risk of injury!

The various material thicknesses require different blade settings or even special blades; it may therefore be necessary to repeat the adjustment described above.

Inserting the blade holder

- First, sufficiently loosen the clamping screw for the blade holder on the cutting head.
- Next, press down the blade holder from above into the hole on the right side until there is contact and pull the lock nut tight. In doing so, please ensure that the blade holder is also secured correctly from above by means of the fixture provided for this purpose.

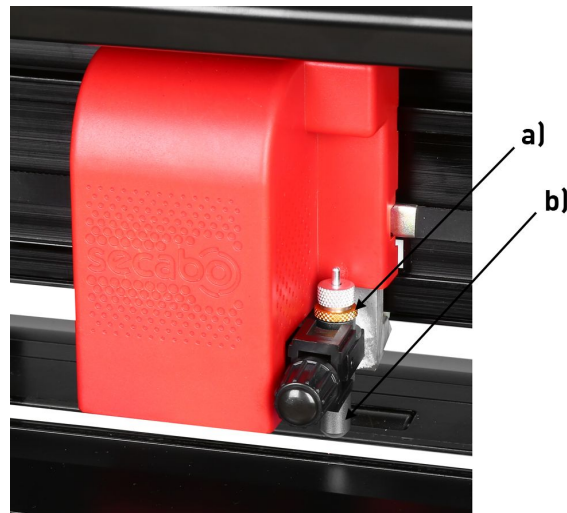

- a) Clamp
- b) Blade holder

Inserting the film

- Always insert the material into the device from the rear.
- Pull the film up to the cutting bar to correctly set the zero point.
- If inserting a roll instead of a film sheet, you can use the supplied holder integrated into the base to ensure the film is rolled off cleanly.

- When inserting, please ensure that the film is inserted straight to prevent warping during transport of the film. Inserting a film even a few millimeters off angle can result in significant deviation of the film when processing large cut jobs.
- You may insert the film into the device at any point, provided the pressure roller is in the area of the black and white rectangles on the crossbar.
- Fixate both pressure rollers by flipping the clamping lever on the rear right side of the device.
- The contact pressure can be changed by tensioning the springs on the individual pinch rollers, should this be necessary.

Cutting test

- Execute the cutting test by clicking the „Test“ button. The vinyl cutter will cut a triangle with a rectangular border into the inserted film/vinyl at the currently saved zero point. Afterwards, the vinyl cutter will move the film up by 20 cm, so that you can easily check the test cut.



- You can check the adjustment of the blade holder as well as the contact pressure with this cutting test. The inserted material should be cut cleanly and straight during the cutting test; the carrier material should not be damaged.
- After reviewing the test cut, press "OK" to move the film back to the zero point.



- If the carrier material has been cut through, either the contact pressure is set too high or the blade or blade holder are set incorrectly. Change these settings and perform the cutting test again.
- Also readjust if the vinyl was cut imprecisely or to an insufficient depth.

The first cut job

- Start the cutting software DrawCut LITE.
- Create a logo or a graphic using the text tool and click on the knife holder icon in the menu bar above.
- The menu "Send to cutting plotter" appears, click on "Cut" in the lower right section of the window.
- Now, the "Vinyl Spooler" opens and displays a preview of the cut job on the right side. Now click on "Cut" and confirm the question with "Yes".
- Start the cutting process!

- The plot can be stopped with the "Pause" key at any time, for example allowing you to adjust knife settings while still in the cut job.



- You can use the "OK" key to continue to run the cut job.



Settings and operation

Moving the cutting head

Pressing the arrow keys lets you move the cutting head left or right, as well as transport the film forwards or backwards. The corresponding X and Y coordinates are shown on the display.

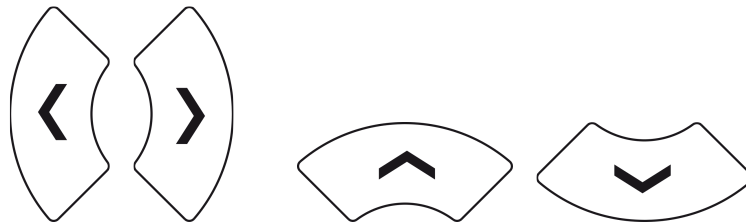

Setting the zero point

To set the correct starting point for cutting, move the cutting head and film using the arrow keys, so that the knife is located in the front right corner of the film. Now confirm this zero point by pressing "OK".

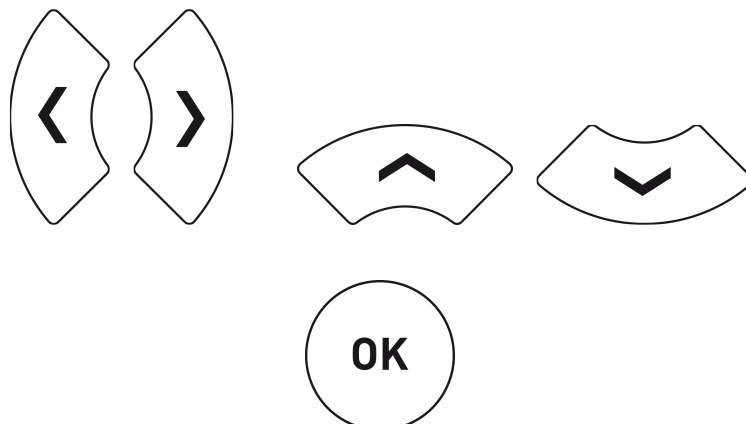

Adjust speed and contact pressure

You can make the following changes by pressing the corresponding buttons: The "+" function is located at the upper end of the button, while the "-" function is at the lower end.

Increase and reduce speed

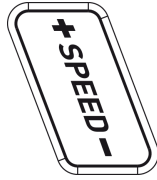

Increase and reduce contact pressure



The cutting speed and contact pressure cannot be changed while a plotting job is in progress.

Other settings

The configuration menu is opened by pressing and holding the "Set" button for 5 seconds.



Use the up and down arrow keys to cycle through the menu options.

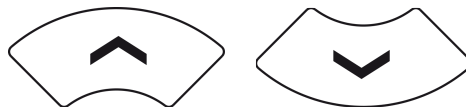

Left and right arrow keys allow you to adjust the relevant values.

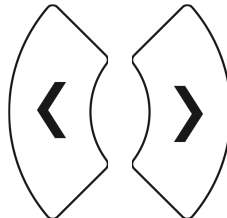

Press the "OK" button to leave the configuration menu at any time.



These settings are queried in sequence:

- Baud rate - configurable to 38400, 57600, or 115200, depending on the value configured for the interface on the computer - only when connecting via serial port.
- XP and YP - in the second and third menu point, you can calibrate the vinyl cutter correctly. Correction may be required here due to wear to the mechanical parts. The X and Y scaling of the data can be changed by changing the XP and YP values. If, for example, an object for which a length of 100 cm was entered on the computer is cut on the vinyl cutter to a length of only 98cm, it is necessary to correct the corresponding scaling value on the plotter. Otherwise, these values should not be changed.
- Reset settings - here you can restore the vinyl cutter's factory settings. To do so, the right arrow key must be held for 3 seconds.



- Firmware - here you can view the firmware version installed on the cutter.

Contour cut with LAPOS

LAPOS is a system for the positioning of printed media in your C V / S II vinyl cutter, allowing you to cut printed elements with absolute contour accuracy, and without misalignment or distortion. The use of LAPOS is explained in the following steps.

Calibration:

Before the first use of LAPOS, the cutter requires an initial calibration to determine the correct laser offset. DrawCut provides two procedures to achieve this, one fast and one detailed option.

- The first step is to open the "Vinyl Spooler".

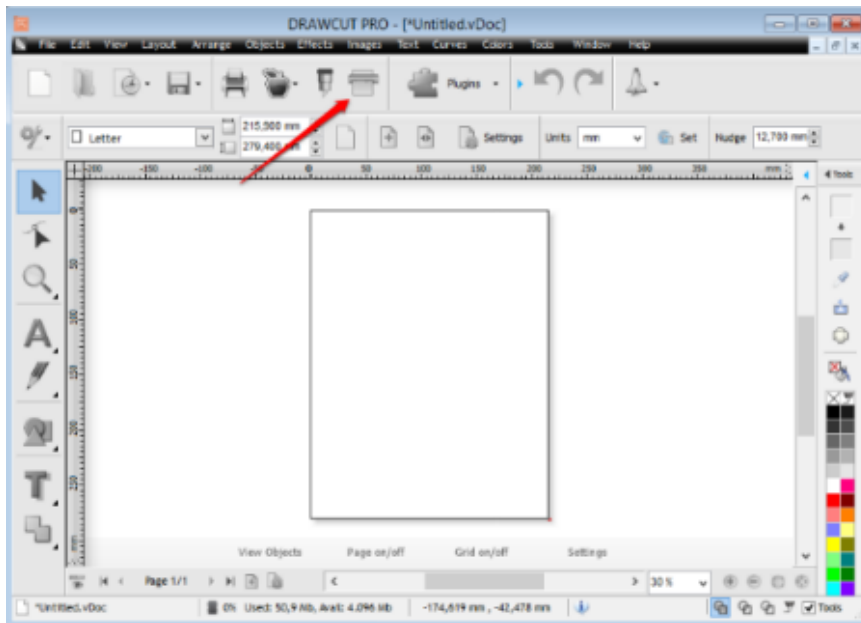

- Click on the "Calibration" tab. Choose the fast or the detailed option and follow the instructions of the respective Calibration Wizard.

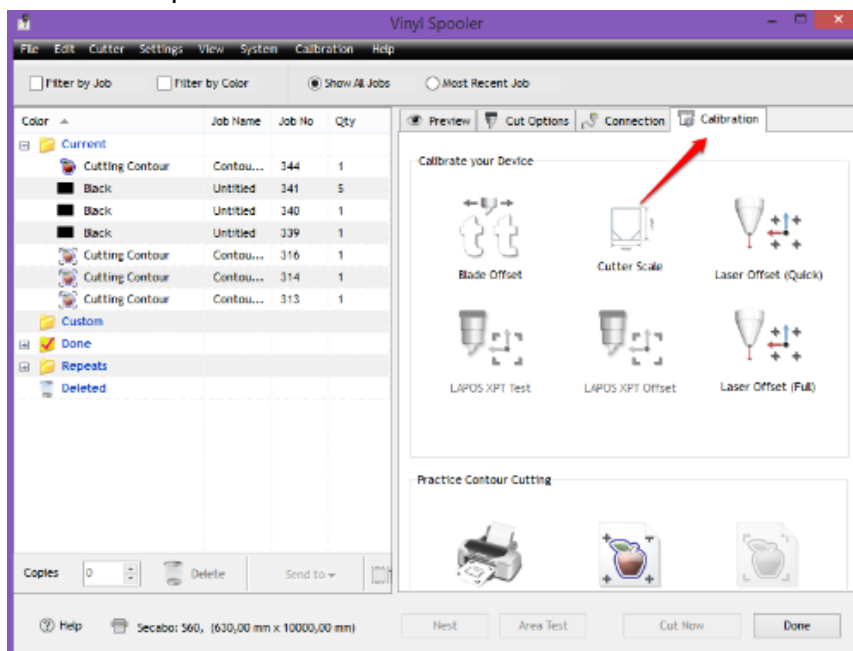

Once the calibration is complete, you can start with the actual contour cutting.

- First, create a logo with the text tool or import any vector graphics.
- Open the Contour Cut Wizard from the DrawCut header.

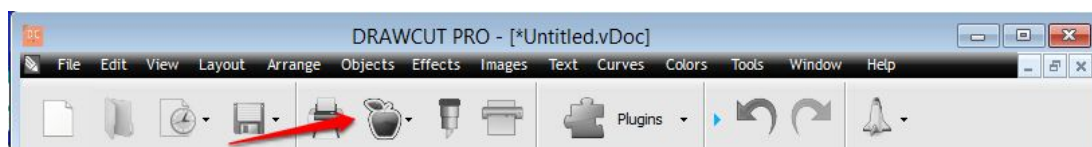

- Create an outline using the desired parameters under "Create a cutting contour". Confirm it by clicking "OK".

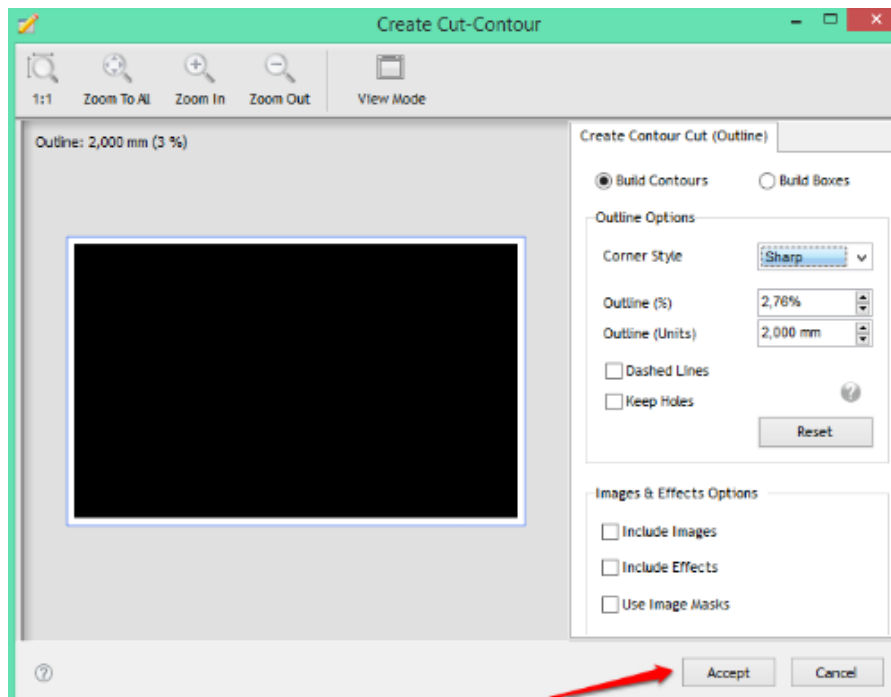

- Now open the Contour Cut Wizard
- First, print out the created graphics including crop marks. Ensure that the printer is configured to print using the actual size.

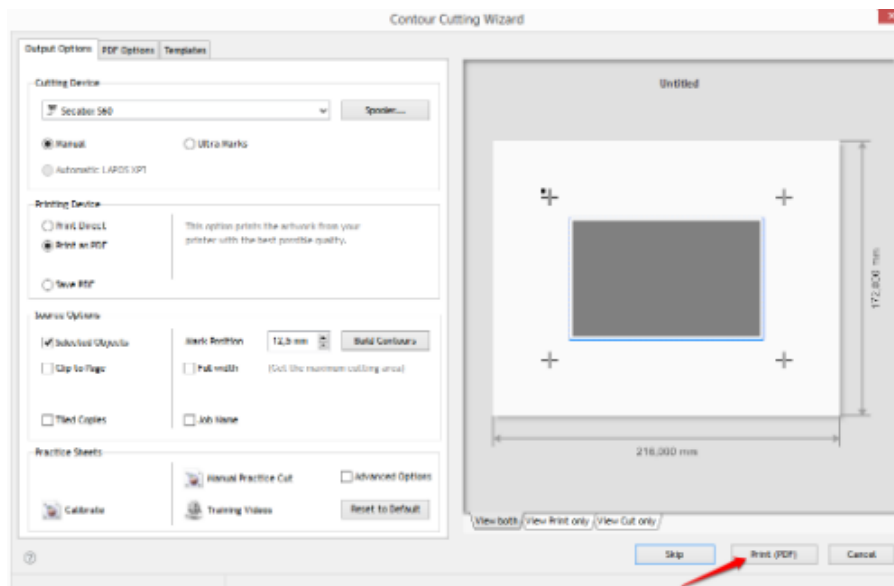

- Once the print job has completed, press the "Cut" button.

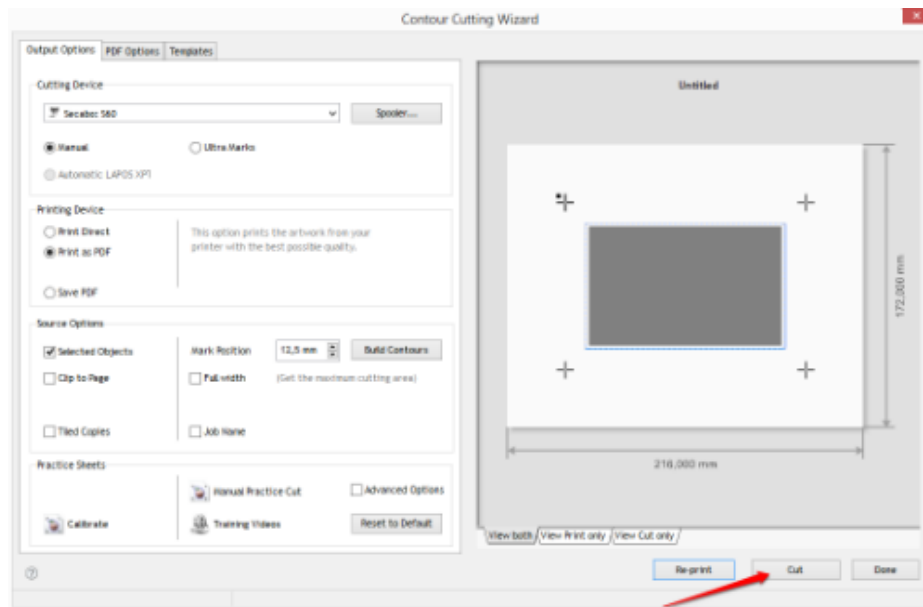

- The Alignment Wizard opens. Ideally you should choose 4 points as "Alignment Method" to achieve the maximum possible accuracy. Place the prinout inside the vinyl cutter exactly as seen in the depiction in the DrawCut application. Now click on the "Next" button and follow the instructions in the alignment wizard to start the contour cutting.

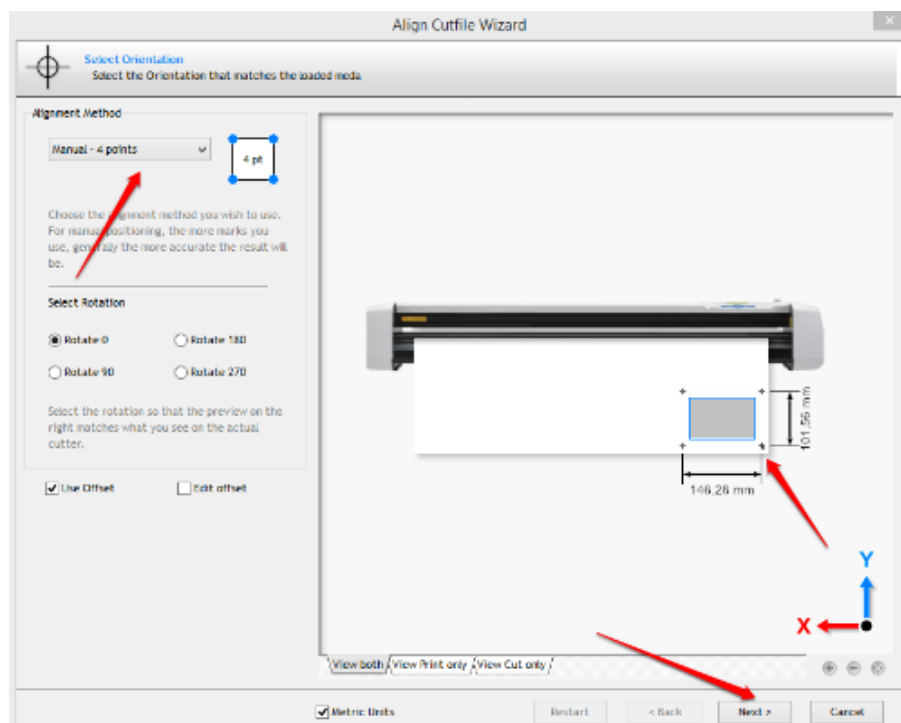

Drag knives

Drag knives are sensitive, sharp and dangerous precision tools.

- Keep the blade out of the reach of children!
- To avoid personal injury, caution must be taken in handling the blades.

Handle the drag knives carefully and always store them with the protection cap when not in use. Should the tip of a blade come hit hard materials such as glass or stone, it can cause tiny fractures of the tip of the blade, making the blade unusable.

Please consider the following instructions to prevent unnecessary wear and tear of your drag knives and to achieve a long durability of these products instead.

- In any case, avoid cuts into the carrier material of the foil. The deeper you cut into the used material, the higher will be the wear and tear of the blade.
- Adjust the cutting depth of the blade so that the material is merely cut cleanly. If the blade protrudes any further, it reduces the durability of the blade and good cutting results can no longer be guaranteed.
- For thicker materials, use knives specially suited for it (e.g. flock knife for flock).
- Frayed edges after cutting the foil indicate a blunt drag knife. Replace worn blades immediately!

Technical data

Model	C60 V	S60 II
Type	Vinyl cutter with stepper motors	Vinyl cutter with servomotors
Max. Media width	720m	
Max. Cutting width	630mm	
Connections	USB	
Display	backlit, graphic LCD screen	
Max. Speed	600mm/s	960mm/s
Max. Media thickness	1mm	
Contact pressure	50g-500g	50g-750g
Mechanical Resolution	0,0245mm	0,01254mm
Repetition accuracy	< +/- 0,1mm	
Power supply	AC 90V - 240V / 50Hz - 60Hz	
Environment	+5°C - +35°C / 30% - 70% relative humidity	
Weight without packaging	15kg	
Weight with packaging	25kg	
Dimensions (W x H x D)	920 x 260 x 260mm	

Model	C120 V	S120 II
Type	Vinyl cutter with stepper motors	Vinyl cutter with servomotors
Max. Medienbreite	1350mm	
Max. Schneidebreite	1260mm	
Anschlüsse	USB	
Display	backlit, graphic LCD screen	
Max. Speed	600mm/s	960mm/s
Max. Media thickness	1mm	
Contact pressure	50g-500g	50g-750g
Mechanical Resolution	0,0245mm	0,01254mm
Repetition accuracy	< +/- 0,1mm	
Power supply	AC 90V - 240V / 50Hz - 60Hz	
Environment	+5°C - +35°C / 30% - 70% relative humidity	
Weight without packaging	30kg	
Weight with packaging	41kg	
Dimensions (W x H x D)	1600 x 260 x 260mm	

Declaration of conformity

Statement of Conformity



We hereby declare under our sole responsibility that the product referred to in "technical data" complies with the provisions of the following directives and standards:

We herewith declare under sole responsibility that the under „technical data“ mentioned product meet the provisions of the following EC Directives and Harmonized Standards:

EC directives / EC directives:

2006/95/EC Low Voltage Directive

2006/95/EC Low Voltage Directive

98/37/EC Directive on machinery (2006/42/EC from 29/12/2009)

98/37/EC Directive on machinery (from 2009-12-29: 2006/42/EC)

Standard / Standard:

EN 60204-1:2006

Technical documents at / Technical documents at:

Secabo GmbH, Hochstatt 6-8, 85283 Wolnzach, Germany

A handwritten signature in black ink, appearing to read 'Fabian Franke', written in a cursive style.

Dipl. Ing. Fabian Franke

A handwritten signature in black ink, appearing to read 'Bernhard Schmidt', written in a cursive style.

Dipl. Ing.(FH) Bernhard Schmidt